

en

# *Lightweight wheelchairs*

Model 2.360 / 2.370

---

## *Operating manual*

---



CE

**MEYRA**<sup>®</sup>  
We move people.

# Contents

<b>Meaning of the applied markers</b>	6
<b>Introduction</b>	6
<b>List of models</b>	6
<b>Indications</b>	6
<b>Acceptance</b>	6
<b>Specifications</b>	6
<b>Use</b>	6
<b>Wheelchair folding/unfolding/carrying</b>	7
<b>Adjustment</b>	7
<b>Reinstallation</b>	8
<b>Life span</b>	8
<b>Overview</b>	9
Model 2.370	9
<b>Overview</b>	10
Model 2.360	10
<b>Brake</b>	11
Pressure brake - user	11
Locking the brakes	11
Releasing the brakes	11
Service brake	11
Butterfly brake - user	12
Locking the brakes	12
Releasing the brakes	12
Service brake	12
Drum brake for accompanying persons	13
Function as operating brakes	13
<b>Leg supports</b>	14
Calf belt model 2.370,	14
Removing the calf belt	14
Attaching the calf belt	14
Length adjustment of the calf belt	14

Heel strap	14
Length adjustment of the heel strap	14
Calf belt model 2.360,	15
Removing the calf belt	15
Attaching the calf belt	15
Length adjustment of the calf belt	15
Lower leg support, model 2.370	16
Footplates	16
Footboard	16
Lower leg support, model 2.360	17
Footboard	17
Upper leg support, model 2.370,	18
Turning the leg supports to the side	18
Swivelling in the leg supports	19
Removing the leg supports	20
Attaching the leg supports	20
Mechanically height-adjustable leg supports	21
Lifting/lowering the leg support	21
<b>Arm supports</b>	22
Removing the arm support	22
Inserting the arm support	23
Swivelling up the arm support	24
Height adjustment of the arm support	24
<b>Clothes guard</b>	25
Clothes guard with padded arm support	25
<b>Push bar</b>	26
<b>Push handles</b>	27
<b>Wheels</b>	28
Drive wheels	28
<b>Manoeuvre rollers</b>	28
<b>Support castors</b>	29
Swinging the support castors	29

<b>Head support</b>	30
<b>Therapy table</b>	30
<b>Retaining strap</b>	31
<b>Basic safety information</b>	32
Accompanying person	32
Transfer out of the wheelchair	32
Reaching for objects	32
Driving on falling, rising or transverse gradients	32
Crossing obstacles	33
Transport in vehicles	33
Transport safety of the empty wheelchair	33
Transport of people inside a motor vehicle	33
Transport in public methods of transportation	34
Driving on public highways	34
Cleaning	34
Finish	35
Disinfection	35
<b>Disposal</b>	35
<b>Maintenance</b>	35
Maintenance	36
Maintenance schedule	37
<b>Technical data</b>	39
Tyre pressure of pneumatic tyres	39
Data according to ISO for model 2.370 Smart S	40
Further technical data for model 2.370 Smart S	41
Data according to ISO for model 2.360 Smart F	42
Further technical data for model 2.360 Smart F	43
Meaning of the symbols on the washing instruction	44
Meaning of the labels on the wheelchair	45
Meaning of the symbols on the type plate	46

<b>Inspection certificate</b>	47
<b>Warranty / Guarantee</b>	48
Warrantee / Guarantee section	49
Inspection certificate for transfer	49
<b>Notes</b>	50

## MEANING OF THE APPLIED MARKERS

Safety instructions with a coloured background are mandatory and need to be observed under any circumstance!

- ☞ This symbol indicates tips and recommendations
- [ ] Reference to a picture number
- ( ) Reference to a function element within a picture.

## INTRODUCTION

Read and observe this manual before first operation. Children and juveniles should read this documentation together with their parents respectively a supervisor or accompanying person before first use.

This operating manual is to help you get accustomed to the handling of the wheelchair as well as to prevent accidents.

Users with visual impairments can find the PDF-files together with further information on our website:

< [www.meyra.com](http://www.meyra.com) >.

- ☞ Contact your specialist dealer when required.

Information about product safety, possible recalls and general handling instructions of our products can be found in the < *Information center* > on our website:

< [www.meyra.com](http://www.meyra.com) >.

Our implemented assembly groups and components fulfil the demands of the norms of correspondence acc. to EN 12183 for durability against inflaming.

## LIST OF MODELS

This operating manual applies to the following models:

Model 2.360 (slanted front section)

Model 2.370 (straight front section)

## INDICATIONS

In case of allergic reactions, skin rashes and/or pressure sores during the use of the wheelchair sores contact a doctor immediately.

If the following indications occur we recommend the application of this mobility product:

- ☞ Walking disability resp. extremely limited walking ability as part of the basic need to move around in your own home.
- ☞ The need to be able to leave home for a short walk in fresh air or in order to reach the places, commonly in the perimeter of the home, required to fulfil basic needs.

## ACCEPTANCE

All products are checked for faults in the factory and packed in special boxes.

- ☞ However, we request that you check the vehicle for possible transport damage immediately on receipt – preferably in the presence of the carrier.
- ☞ The packaging of the wheelchair should be stored for a further transport that might become necessary.

## SPECIFICATIONS

The wheelchair was developed for adults. The wheelchair solely serves to transport one person in the seat and not as a hauling aid, transporter or similar.

## USE

Do not reach into the spokes or grip the tyres of the rotating wheels. – Danger of injury!

Do not reach into the space between the pressure brake and the tyre when propelling the wheelchair. – Danger of injury!

Avoid a jerky propulsion of your wheelchair. – Danger of tipping over or tilting!

Do not use the wheelchair without attached leg supports and arm support units!

The wheelchair is applicable on level, firm surfaces and can be used as follows:

- for indoors (e.g. apartment, day care),
  - outdoors (e.g. paved paths in parks),
  - as a companion on tours (e.g. in a bus or train).
-  Your wheelchair with a seat width of more than 500 mm is not suited for transport in a train.
- Never expose the wheelchair to extreme temperatures and damaging environmental conditions, such as sunlight, extreme cold or salty water.
  - Sand and other dirt particles can seize on moving parts and render them without function.
  - Use only the handrims on the drive wheels to propel your wheelchair.

You must not let yourself be carried in your wheelchair by having the wheelchair lifted from the floor. Parts that are not securely fixed, e.g. side elements or leg supports, can come away and thus cause an accident.

 The wheelchair is a vehicle and not a carrying device.

Only apply the wheelchair within the scope of the specifications and limitation described in chapter *Technical data* on page 39.

## WHEELCHAIR FOLDING/ UNFOLDING/CARRYING

Your wheelchair can be folded without the aid of tools.



1. Remove the seat cushion, if applicable.
2. Lift up the footplates or remove the leg supports.
3. Pull the seat belt upward in the centre of the front and back.
4. If necessary remove the connection rod of the double handrim drive or the push bar.

Your wheelchair can be carried without difficulty when folded.

For this, push one lower arm from the front under the upward folded seat belt. Place other hand underneath the rear seat fold for support.

Lift the wheelchair to horizontal position.

Tip the wheelchair slightly to one side in order to make the unfolding easier. At the side resting on the floor, press the seat tube down to the end stop.

-  You may need to press down both seat tubes with the hands in order to do this.
-  Ensure that the seat tube sits securely on the support surface.

## **ADJUSTMENT**

Always have adaptation and adjustment work carried out by a specialist dealer.

The wheelchair offers manifold adjustment possibilities to individual vital statistics. The wheelchair should be adapted to your needs by a specialist dealer before the first use. The adaptation will take into account the driving experience, the physical limits of the user and the main place of use of the wheelchair.

- ✎ We recommend a regular control if the wheelchair adjustment in order to ensure a long-term optimal provision even with changing illness/handicap patterns of the user.

## **REINSTALLMENT**

The wheelchair is suited for reinstallation. With the building block system the wheelchair can be fit to accommodate different handicaps body sizes. Before reimplementation the wheelchair is to undergo a complete inspection.

- ✎ Hygienical measures required for reinstallation are to be carried out according to a validated hygienic plan and must include disinfection.

## **LIFE SPAN**

We expect an average life span of about 4 years for this product, as far as the product is applied for its designated purpose and all maintenance and service guidelines. The life span of your product depends upon the frequency of use, the application environment and care. The implementation of spare parts can prolong the life span of the product. As a rule spare parts are available up to 5 years after production is discontinued.

- ✎ The indicated lifespan does not constitute additional guarantee.



# OVERVIEW

## Model 2.370

The overview shows, representative for all models, the most important components of the wheelchair.

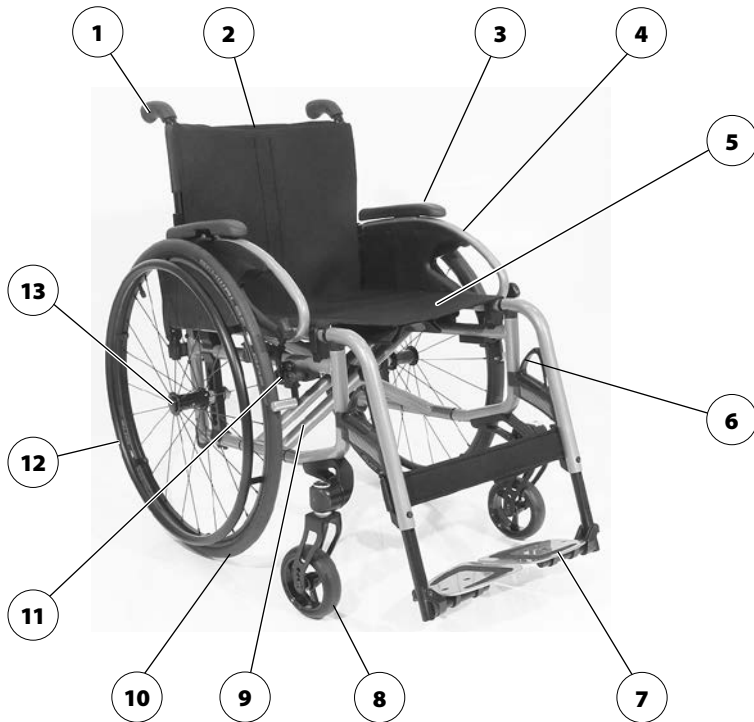

Pos. Description

- |                                  |  |
|----------------------------------|--|
| (1) Push handle                  | (8) Steering wheel                     |
| (2) Back support                 | (9) Type plate                         |
| (3) Arm support                  | (10) Driving wheel                     |
| (4) Clothes guard                | (11) Brake lever – pressure brake      |
| (5) Seat belt/seat cushion       | (12) Handrims                          |
| (6) Locking lever – Leg support  | (13) Locking knob – Quick release axle |
| (7) Footboard/footplates divided |  |

# OVERVIEW

## Model 2.360

The overview shows, representative for all models, the most important components of the wheelchair.

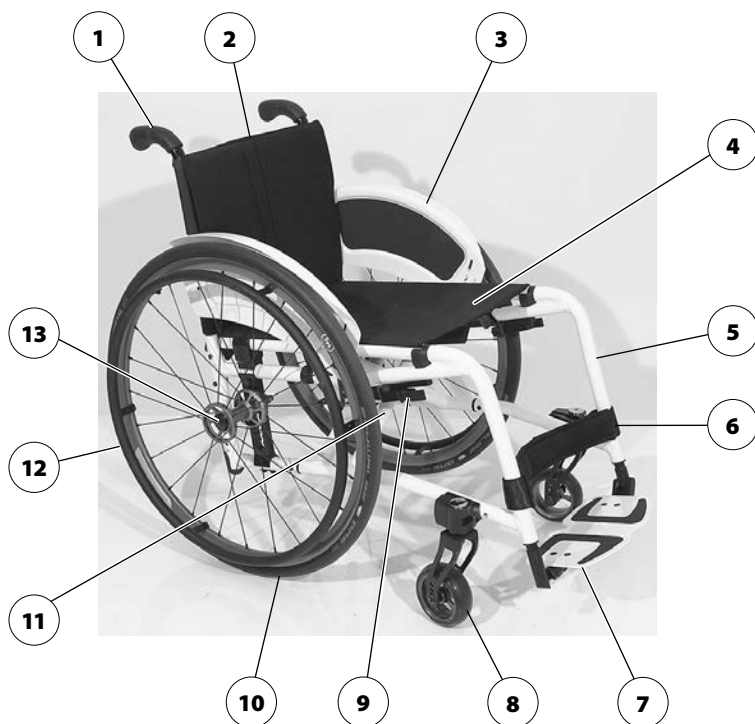

Pos. Description

- |                                  |  |
|----------------------------------|--|
| (1) Push handle                  | (8) Steering wheel                     |
| (2) Back support                 | (9) Brake lever – pressure brake       |
| (3) Clothes guard                | (10) Driving wheel                     |
| (4) Seat belt/seat cushion       | (11) Type plate                        |
| (5) Slanted front section        | (12) Handrims                          |
| (6) Calf belt                    | (13) Locking knob – Quick release axle |
| (7) Footboard/footplates divided |  |

# BRAKE

Arrange an immediate repair of the brakes by your specialist workshop if the braking performance reduces.

Wheelchairs with PU-tyres should be stored safely without activated pressure brakes in case of longer standing periods.

By locking the brakes with the brake lever (1), the wheelchair is secured against rolling away unintentionally (parking brake).

Depending on the version, the wheelchair can be equipped with pressure brakes (2) or with drum brakes (3).

☞ Therefore observe the *Maintenance schedule* on page 37.

## Pressure brake - user

### Locking the brakes

To secure the wheelchair against any unintentional rolling, press both brake levers forward all the way [4].

☞ It should not be possible to push the wheelchair forward when both brakes are locked.

### Releasing the brakes

Pull both brake levers back all the way [2].

### Service brake

The wheelchair is braked down with help of the handrims.

☞ If needed use suitable gloves in order to brake down the wheelchair.

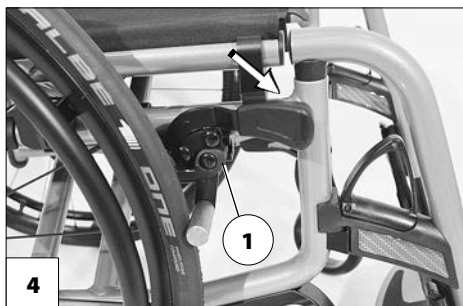
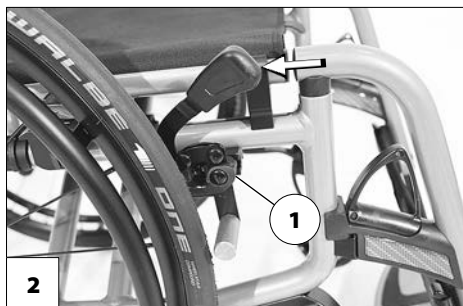

## Butterfly brake - user

### Locking the brakes

To secure the wheelchair against any unintentional rolling, swivel both brake levers outward all the way [2].

- ☞ It should not be possible to push the wheelchair forward when both brakes are locked.

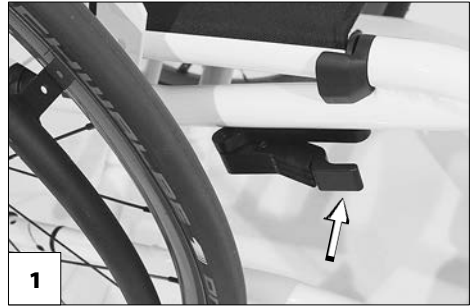

### Releasing the brakes

Swivel both brake levers inward all the way [1].

### Service brake

The wheelchair is braked down with help of the handrims.

- ☞ If needed use suitable gloves in order to brake down the wheelchair.

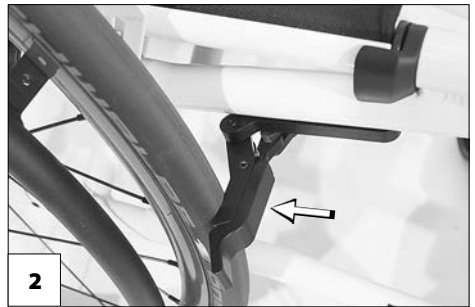

## Drum brake for accompanying persons

Model 2.370

The drum brake is activated by the accompanying person through the brake levers [1].

### Function as operating brakes

Use both brake levers evenly and only lightly in order to achieve a controlled deceleration of the wheelchair.

### Locking the drum brakes

Pull both brake levers [1] and press the locking latch (2) forward.

Release the brake lever. – Depending on the adjustment the latch engages in the first (A) or second (B) locking position and activates the brake.

☞ If the third locking position (C) is required to activate the brake, it must be readjusted by a specialist workshop.

### Loosen the drum brakes

Pull both brake levers (1) until the latches (2) automatically jump out of the locking points.

Let go of both brake levers. – The parking brakes are released and the wheelchair ready for use.

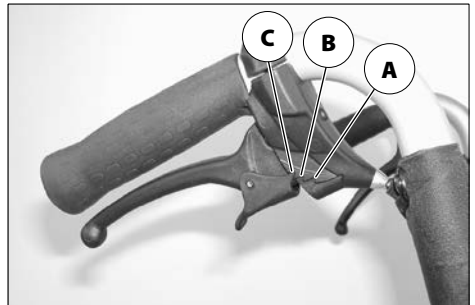
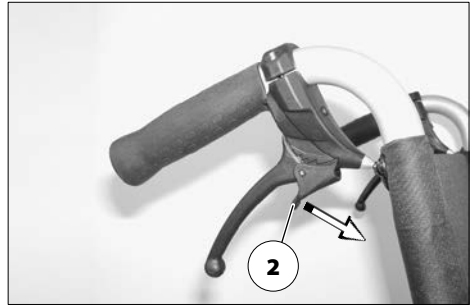

## LEG SUPPORTS

Before any actions on the leg supports the wheelchair is to be secured against unintentional rolling motions.

- Therefore observe chapter *Brake* on page 11.

### Calf belt model 2.370,

Do not drive without the calf belt. – Danger of accidents.

The removable calf belt (1) prevents the feet from sliding off the back of the footboard.

- The calf belt must be removed in order to swivel away the leg supports.
- The calf belt is omitted for height adjustable leg supports and is replaced by a calf pad.

### Removing the calf belt

For removal the calf belt is to be pulled from the attachment pins (2).

### Attaching the calf belt

For attachment both loops of the calf belt are slid over the attachment pins (2).

### Length adjustment of the calf belt

For length adjustment, the calf belt is guided around the special attachment pins (2) and adjusted in length with a velcro fastener.

### Heel strap

The heel strap (3) prevents the feet from sliding off the back of the footplates.



### Length adjustment of the heel strap

For length adjustment, the heel strap is guided around the special attachment pins (2) and adjusted in length with a velcro fastener.

## Calf belt model 2.360,

Do not drive without the calf belt. – Danger of accidents.

The removable calf belt (1) prevents the feet from sliding off the back of the footboard.

- ✎ The calf belt must be removed in order to swivel away the leg supports.
- ✎ The calf belt is omitted for height adjustable leg supports and is replaced by a calf pad.

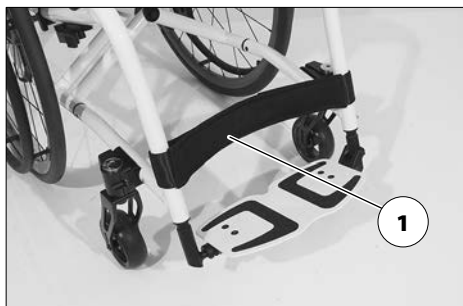

### Removing the calf belt

To remove the calf belt, open the velcro fastener (2).

### Attaching the calf belt

To attach the calf belt, guide it around the slanted frame tube [3] and close the velcro fastener (2).

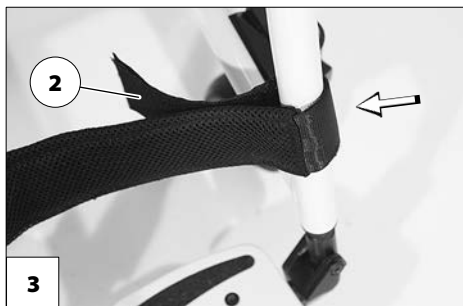

### Length adjustment of the calf belt

For length adjustment, the calf belt is guided around the slanted frame tubes [3] and adjusted in length with a velcro fastener (2).

## Lower leg support, model 2.370

The footplates, resp. footboard needs to be folded up before entry or exit [1].

- ☞ Check the locking points!
  - Remove both feet from the footplates.
  - Remove lower calf belt, if present.
- ☞ Therefore observe chapter *Calf belt model 2.370*, on page 14.
- ☞ Before starting to drive the footplates resp. footboard need to be folded back down [3] and the calf belt attached.

### Footplates

The footplates can be folded outward and up [1] resp. inward and down [3].

### Footboard

Fold the footboard up before swivelling away and removing the upper leg support [4].

### Folding up the footboard

In order to fold up the footboard lift the loose end of the footboard as far as possible [4].

### Folding the footboard down

In order to fold down the footboard, lower the loose end of the footboard as far as possible down onto the footboard bracket [5].

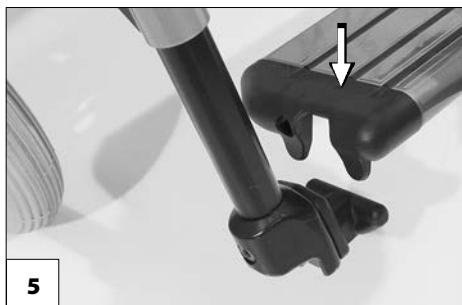



## Lower leg support, model 2.360

The footplates, resp. footboard needs to be folded up before entry or exit [1].

- ☞ Check the locking points!
  - Remove both feet from the footplates.
  - Remove lower calf belt, if present.
  - ☞ Therefore observe chapter *Calf belt model 2.370*, on page 14.
- ☞ Before starting to drive the footboard need to be folded back down [3] and the calf belt attached.



### Footboard

The footboard can be folded upward for entering or exiting into/out of the wheelchair [4].

#### Folding up the footboard

In order to fold up the footboard lift the loose end of the footboard as far as possible [4].



#### Folding the footboard down

In order to fold down the footboard, lower the loose end of the footboard as far as possible down onto the footboard bracket [5].

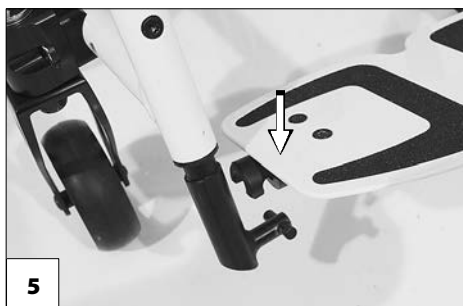

## Upper leg support, model 2.370,

The upper leg support with an inserted lower leg support is termed leg support.

### Turning the leg supports to the side

Leg supports turned to the side are released automatically and can easily come off. Note this when handling (e.g. transport).

For easy transfer out of/into the wheelchair as well as driving closer to a closet, bed or bathtub the leg supports can be swivelled away toward the in-/outside [1].

- ☞ Remove the calf belt, if applicable, before swivelling away the leg supports.
- ☞ Therefore observe chapter *Calf belt model 2.370*, on page 14.

Fold up the footplates resp. footboard in order to swivel away the leg supports.

- ☞ Therefore observe chapter *Lower leg support, model 2.370* on page 16.

Afterwards pull or press the respective locking lever (2) backward and swivel the corresponding leg support outward.

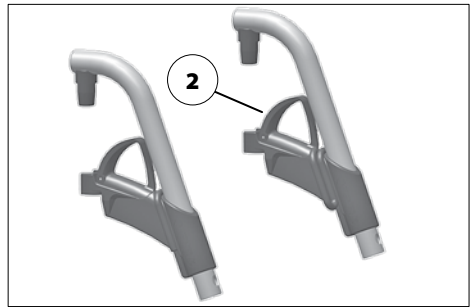

## Swivelling in the leg supports

For inward swivelling, let the leg supports swivel forward until the lock audibly engages [1].

- ☞ After audibly swivelling the leg supports inward check the respective locking device.
- ☞ Afterwards observe chapter *Lower leg support, model 2.370* on page 16.



## Removing the leg supports

For easy transfer into and out of the wheelchair as well as a reduced wheelchair length (important for transport) the leg supports can be removed [1].

- Remove the calf belt before swivelling away the leg supports.
  - Therefore observe chapter *Calf belt model 2.370*, on page 14.

For removal first swivel the leg support sideways [2] and then remove them toward the top [1].

- Therefore observe chapter *Turning the leg supports to the side* on page 18.
- Watch for possible danger of jamming!

## Attaching the leg supports

For inserting press the leg supports, swivelled to the side, parallel to the front frame tube and lower it into place. – In doing so the holding pin must slide into the frame tube.

- After attachment swivel the leg supports inward [3].
  - Therefore observe chapter *Swivelling in the leg supports* on page 19.



## Mechanically height-adjustable leg supports

Never put the free hand into the adjustment mechanism. Have the leg support secured by an accompanying person against unintentionally falling down. Do not let the leg support drop on its own weight. – Danger of injury!

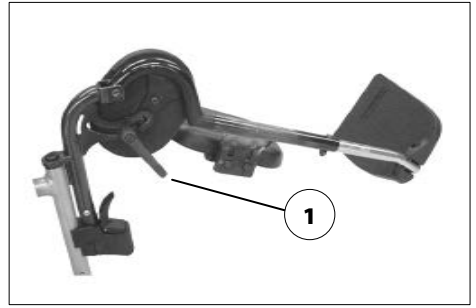

### Lifting/lowering the leg support

Before lifting/lowering relieve the leg support by an accompanying person by slightly lifting it up.

Afterwards loosen the clamping lever (1) and have the leg support lifted/lowered slowly to the desired level by an accompanying person.

After the adjustment retighten the clamping lever (1).

# ARM SUPPORTS

Do not use the arm supports to lift or carry the wheelchair.

Do not drive without the arm supports.

No not grab between the frame and arm support. – Danger of squashing!

When the wheelchair is being pushed by an attendant the user is to place his hands onto the arm cushions or in his lap and not at the sides between body and arm support. – Danger of squashing the fingers!

The arm supports [1] can (depending on the model and version) be removed, are height adjustable and at the same time serve as a padded arm support, clothes guard and wind breaker.

## Removing the arm support

(Model 2.370)

To remove the arm supports, activate the locking device (3) and swivel the arm support upward [4].

Afterwards remove the arm support toward the top [2].



## Inserting the arm support

(Model 2.370)

First insert the arm support from the top into the guide tube behind the seat surface [1].

Then swivel the arm support down until the locking device audibly engages (2).

- ☞ The tube of the back support must lie in the guide groove on the arm support (3).

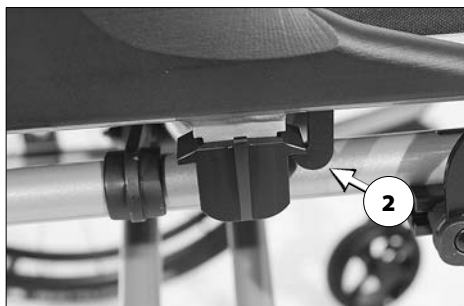

## Swivelling up the arm support

(Model 2.370)

For transfer out of/into the wheelchair the arm support can be swivelled upward [1] as well as folded behind the back support [2].

Release the locking device (3) first before swivelling up the arm support.

Afterwards swivel the armsupport upward [1] and if needed fold it behind the back support [2].

- ⚠ On the version with drum brakes or low back support height the arm support cannot be folded behind the back support.

## Height adjustment of the arm support

(Model 2.370)

The upholstered arm support pads can be height adjusted in 5 steps [4].

For lifting or lowering the padded arm support, pull or press the lever (5) with your fingers and at the same time slide the padded arm support to the desired height. Afterwards slide the padded arm support again until it audibly locks into place.

- ⚠ Check the locking device by trying to pull or push the padded arm support.

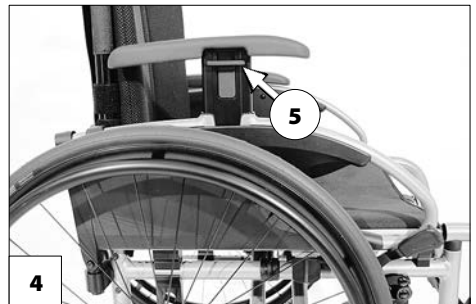



## **CLOTHES GUARD**

Do not grab hold of the clothes guard [1] +[2] to lift or carry the wheelchair.

Do not drive without the clothes guard!

No not grab between the frame and clothes guard. – Danger of squashing!

When being pushed in the wheelchair by the accompanying person the user has to keep his hands on the arm supports or in his lap and not at the sides between body and arm support. – Danger of squashing the fingers!

### **Clothes guard with padded arm support**

The clothes guard with arm support [2] is height adjustable and at the same time serves as a padded arm support, clothes- and wind protector.



## **PUSH BAR**

Before any actions on the push bar the wheelchair is to be secured against unintentional rolling motions. – View chapter *Brake* on page 11.

The removable push bar connects the two back support tubes at the pushing handles [1], serves to push the wheelchair and at the same time is the bracket for the head support.

To remove the push bar or to fold the wheelchair unscrew one or both of the attachment screws (2) completely.

- ☞ While doing so protect the push bar from falling down.
- ☞ Screw the previously removed screw(s) back into the tube. – This will ensure that no screws are lost.

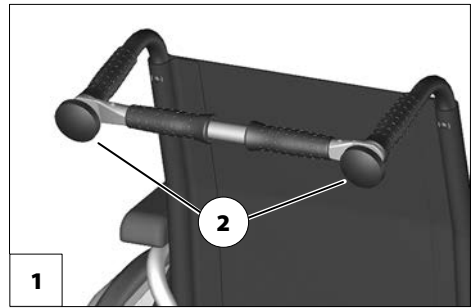

# PUSH HANDLES

The height adjustable push handles are about 20 cm continuously height adjustable and secured against being pulled out [1].

## Push handles with clamping device

- ☞ In doing so, hold onto the push handle that is to be adjusted with one hand.
- ☞ After each adjustment the clamping lever is to be tightened sufficiently, so that the push handle cannot be turned anymore.

### Height adjustment:

Loosen the clamping screw with the clamping levers (2) so far that the respective push handle can be adjusted into the desired position.

### Angle adjustment:

In order to turn the push handles, loosen the clamping screw through the clamping lever (2) and turn into the desired position.

### Extracting/inserting:

1. Press down the respective spring button (3) in order to extract or insert the push handles.
2. Afterwards retighten the clamping screw with the clamping levers (2).

## Special features of the clamping lever

The clamping lever (2) can be turned into an operation position that is comfortable for you.

For this pull the clamping lever (2) outward (direction of the arrow), until the teething is released.

After turning the clamping lever (2) let the teething snap back into place.

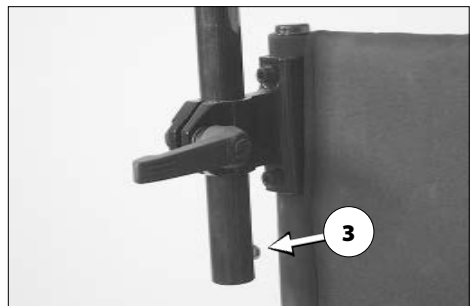
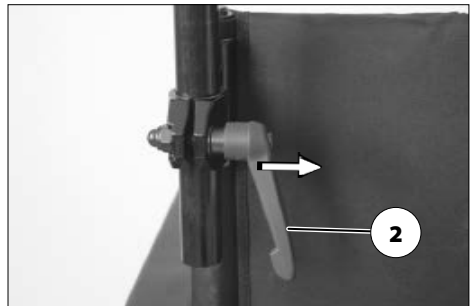

# WHEELS

## Drive wheels

After inserting the drive wheel the locking button (2) must stick a couple of millimetres out of the wheel nut.

The drive wheels are supported on a quick release axle [1] and can be removed resp. attached without tools.

First press the locking button (2) of the quick release axle in the center of the hub.

Afterwards remove or attach the drive wheel.

- ✎ The air pressure value for the tyres of the wheelchair can be read in the *Technical data* on page 39 or details on both sides of the tyre cover.
- ✎ If the drive wheels has too much side-ward lag or the quick release axle does not engage, contact your specialist dealer immediately for repair.
- ✎ No person may be seated in the wheelchair during assembly or removal. The wheelchair should stand on a level and firm surface. Before starting the disassembly work, support the frame to prevent the wheelchair from tipping over and secure it to prevent an unwanted movement or tipping over.

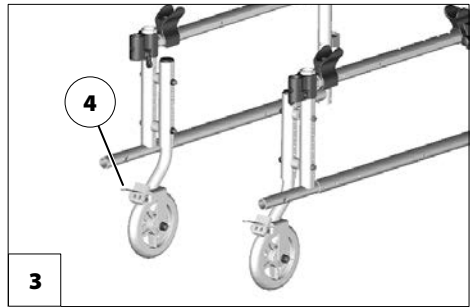
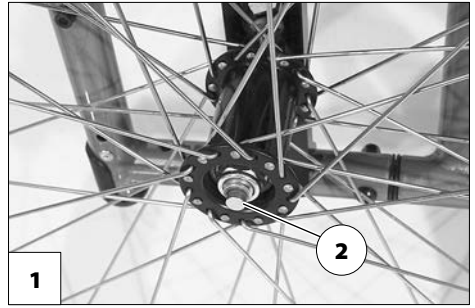

- ✎ When parking the wheelchair the brakes of the shunting castors (4) are to be engaged.

## MANOEUVRE ROLLERS

With active shunting castors the wheelchair cannot be braked resp. secured through the brake levers.

The shunting castors [3] enable shunting in tight spaces.

- ✎ When the drive wheels are attached the shunting castors have no function.

## **SUPPORT CASTORS**

Support castors do not provide sufficient protection against tipping over in certain situations.

The support castors [1] serve to raise the tilting stability and can be swivelled inward underneath the seat (2).

- ☞ Depending on the version the support castors can be attached singly or as a pair.
- ☞ Swivelling of the support castors can be done by an accompanying person or aid.

### **Swinging the support castors**

Press the support castors out of the locking then swivel them inward resp. outward until the lock engages automatically [2].



## HEAD SUPPORT

A headrest mounted to the wheelchair serves as a support for the posture of the head, not as a transport security.

The upper edge of the adjustable head support [1] should always be close to the back of the head at about eye level. For height adjustment and removal of the head support loosen the clamping screw (2).



## THERAPY TABLE

Sharp objects (e.g. watches, rings, knives or belt buckles) as well as coarse dust can cause unattractive brush marks in the surface of the therapy table.

Do not place any hot objects onto the therapy table.

Do not drive with the therapy table attached when there are loose objects or containers with fluids on it.

Do not use aggressive or granular cleaning agents to clean the therapy table.

Do not use the therapy table as handle for carrying the wheelchair.

The therapy table is pushed from the front over the arm support cushions [3].

- ☞ Ensure that the therapy plate sits securely on the arm supports pads.



## RETAINING STRAP

Make sure that no objects are trapped between belt and the body!

The retaining strap is not part of the retaining system for the wheelchair and/or the driver during transport in motor vehicles.

The retaining strap [3] is screwed from the back onto the respective back support tube. The retaining strap serves to stabilise the sitting position and prevents falling forward out of the wheelchair.

To fasten the retaining strap, pull both ends forward and audibly let the buckle click into place. To open the retaining strap press in both clips and pull the ends of the straps apart.

- ⚠ The retaining straps can be adjusted in length and should not be pulled too tight.



# **BASIC SAFETY INFORMATION**

## **Accompanying person**

The accompanying person must be made aware of all possible danger situation before the start of his/her supportive involvement. The parts of your wheelchair that are held onto by the accompanying person are to be checked for tight fit.

## **Transfer out of the wheelchair**

Drive with the wheelchair as closely as possible to the spot where you want to switch out of the wheelchair.

- ☞ Herefore additionally observe chapters *Brake* on page 11 and *Swivelling up the arm support* on page 24.
- ☞ We recommend to conduct the transfer from the wheelchair together with an aid.

## **Reaching for objects**

Avoid an extreme forward or backward inclination of the upper body when picking up or placing heavy objects. – Danger of wheelchair tipping over, especially in the case of narrow seat widths and high seat heights (seat cushion)!

## **Driving on falling, rising or transverse gradients**

For safety reasons, the maximum permitted gradient is limited because the tip-over stability and the braking and steering behaviour are impaired by a reduced floor/road.

- ☞ Observe chapter *Technical data* on page 39.

For your own safety, we recommend that you use the assistance of an accompany-

ing person for driving slopes of more than 1% tilt.

- ☞ This low gradient value is valid for persons that are not able to effect even the smallest centre of gravity change by changing the position of their upper body.

The accompanying person should be aware that the control of the wheelchair requires more strength on a downward slope/ hills than on a level driving surface and that there is an increased danger of slipping.

Never lean towards the downhill direction when driving on rising, falling or transverse gradients.

Avoid jerky changes of the driving condition (especially with critically adjusted driving parameters as for example an active wheel position).

Never drive faster than walking speed.

There is an increased danger of tilting while driving backwards.

While driving in curves and when turning on inclinations and slopes there is a danger of tilting.

The braking force transferred to the driving surface is much less on a downward slope than on a level driving surface and is further reduced by poor road conditions (e.g. rain, snow, grit, dirt). A dangerous slipping of the wheels due to excessive braking and an associated unwanted course deviation must be avoided by way of a careful dosed braking.

At the end of the downward slope, take care that the foot plates do not make contact with the ground and endanger you through a sudden braking effect.

Transverse surfaces to the driving direction (e.g. transversely sloped pavements) effect a turning of your wheelchair in the downhill direction. You or an accompanying person



must compensate for this drift by a counter-steering

## Crossing obstacles

After overcoming obstacles, the previously removed support castors need to be reattached.

Each crossing of obstacles involves a risk! Even flat obstacles (e.g. sills, carpet edges, small steps or similar) represent a danger of tipping.

The crossing of obstacles is a special danger situation in which a combination of the safety advice in the sections headed uphill driving, downhill driving and driving transverse to a slope must be observed in addition to other safety advice.

For your own safety all obstacles should only be driven over with an accompanying person.

The unassisted, safe, crossing of small obstacles (< 4 cm) is only possible with a sufficiently safe control of the wheelchair.

Always approach small obstacles, e.g. steps or curbs, slowly and at a right angle (90°) until the steering wheels almost touch the obstacle. Briefly stop the wheelchair and then drive over the obstacle.

Always drive over an obstacle forwards (not backwards) and simultaneously with both front/rear wheels in order to prevent a sideways tipping of the wheelchair.

Always maintain a safety distance between the wheelchair and drops, stairs and similar obstacles sufficient for reaction, braking and turning.

If possible, let one or more helpers lift you out of the wheelchair and carry you to the destination point.

The crossing of stairs is only possible with the assistance of two helpers who are fa-

miliar with the danger situation and firmly guide the wheelchair.

☞ The helpers may only hold (without lifting) the wheelchair with the push handles and the side frame.

Existing support castors are to be removed, since they might pose a danger to the aid under certain circumstances.

## Transport in vehicles

The following procedures may be necessary due to lack of space for the transport in vehicles:

- Remove the leg supports.
- Remove the arm supports.
- Remove or fold over the back support.
- Detach drive wheels

The parts detached for the transport must be carefully stowed and carefully attached again before the next journey!

## Transport safety of the empty wheelchair

Changes on the wheelchair and especially the anchor points may not be made.

All regulations and directions of the respective transport company are to be observed.

☞ Ask for these before the transport.

Only attach the fastening straps to designated parts of the car and wheelchair.

☞ View chapter *Meaning of the labels on the wheelchair* on page 45.

## Transport of people inside a motor vehicle

Your wheelchair is only permitted as a seat for person transport in a vehicle if a corresponding symbol is shown on the type plate. Limitations to the user weight can be found in on the type plate or in chapter *Technical data* on page 39.

- 🔊 Observe the guideline < *Safety with Meyra-wheelchairs, also during transport in motor vehicles* >! – This document and further information are available in the < *Infozentrum* > on our website < [www.meyra.com](http://www.meyra.com) >

## Transport in public methods of transportation

Your wheelchair is not designed for user transport in public transportation vehicles. Limitations may occur. We recommend use of one of the firmly built in seats of the public vehicle.

Should it nevertheless become necessary to carry out the transport while sitting in the wheelchair, the following needs to be observed:

- Use the space designated by the public transportation services for parking.
- Observe the regulations of the transport company before parking the wheelchair.
- Park your wheelchair opposite to the driving direction in the reserved space.
- The wheelchair is to be placed so that the back support it will be supported by the border of the parking space.
- One side of the wheelchair must also lie against the border of the parking space, so that the wheelchair cannot slide away in case of an accident or sudden braking manoeuvre.
- Additionally activate the parking brakes.

## Driving on public highways

In Germany you are subject to the German laws for traffic regulation (Strassenverkehrsordnung (StVO)) as a pedestrian.

Your wheelchair is equipped by the manufacturer with reflectors on the back support and drive wheels.

With limited visibility and especially in the dark we recommend to mount active lighting equipment and to turn it on in order to see better and be seen.

- 🔊 When participating in public traffic the user is responsible or the functional- and operationally safe condition of the wheelchair.
- 🔊 When driving in the dark avoid using the road or bicycle lanes.
- 🔊 Ensure that the vehicle headlights, indicators, rear lights and reflectors are not covered by clothing or by items secured to the vehicle.

## Cleaning

The plastic panelling is attacked through non-ionic tensides as well as solvents and especially alcohol.

The cushions and covers are normally fit with care instructions (instruction for care). In all other cases the following information is true:

- ☞ Clean the upholstery with warm water and hand washing liquid.
- ☞ Remove spots with a sponge or a soft brush.
- ☞ Wash off persistent dirt with commercial fine detergent.
- ☞ Do not soak! Do not machine wash!

Follow-up with clean water and allow to dry.

The chassis, reflectors and wheels can be cleaned damp with a mild detergent. Afterwards dry off well.

- ☞ Check the chassis for corrosion damages as well as other damages.
- ☞ Only clean the plastic parts with warm water and neutral detergent or soft soap.

Further information to cleaning can be found in the < *Infozentrum* > on our website: < [www.meyra.com](http://www.meyra.com) >.

## Finish

The high quality finish ensures an optimum of protection against corrosion.

- ☞ For paint and chrome care the commercially available brand name paint and chrome cleansers are recommendable.
- ☞ Should the coating be damaged with scratches or similar, these areas can be touched up with our paint pen available at the specialist dealer.

Slight lubrication of moving parts will ensure for their long functioning.

## Disinfection

If the product is used by more than one person (for example in a care centre), the use of a commercial disinfectant is mandatory.

- ☞ Before disinfection the upholstery and handles are to be cleaned.
- ☞ A spray- or wiping disinfection is permitted with tested and accredited disinfectants.

A list of the disinfectants and disinfection means tested and approved by the Robert Koch Institute can be found under:

< <http://www.rki.de> >.

- ☞ During the use of disinfectants it can happen that surfaces might be affected in such a fashion that the long term functionality of parts can be limited.
- ☞ In doing so the manufacturers instructions are to be observed.

## **DISPOSAL**

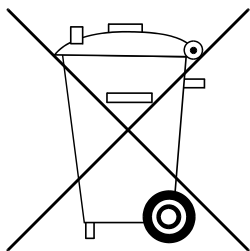

The disposal must comply with the respective national law.

Please enquire about local disposal arrangements at your municipal authority.

## **MAINTENANCE**

An incorrect or neglected cleaning and maintenance of the wheelchair results in a limitation of the product liability.

### **Maintenance**

The following maintenance Instruction gives you a guide for carrying out the maintenance work.

- ✎ They do not give information about the actual extent of work required on the wheelchair.

## Maintenance schedule

WHEN	WHAT	REMARK
<b>Before starting out</b>	<b>General</b> Test for faultless operation.	Carry out test yourself or with a helper.
<b>Before starting out</b>	<b>Test brakes for faultless operation</b>  Activate brake lever to the limit.	Carry out test yourself or with a helper.  The locked wheels should not be able to turn under operating conditions. If they can still turn, the brakes must be repaired by an authorised specialist workshop.
<b>Before starting out</b>	<b>Check pressure brake for wear</b>  Move brake lever to the side	Carry out tests yourself or have a helper do it. If you notice any increasing slackness on the brake lever take the wheelchair to your specialist workshop immediately for repairs. – Danger of accident!
<b>Before starting out</b>	<b>Check the back tubes and frame tubes for damages</b>	Carry out the test yourself or by a helper. If deformations or cracks occur in the welding seams, contact a specialist workshop immediately for repairs. – Danger of accident!
Especially before driving in the dark (when applicable)	<b>Check the lighting</b> Check the light- and indicator signal equipment as well as reflectors for immaculate performance.	Carry out test yourself or with a helper.

WHEN	WHAT	REMARK
<b>Every 2 weeks</b> (depending on distance covered)	<b>Check air pressure of the tyres</b>  Tyre filling pressure:  View <i>Tyre pressure of pneumatic tyres</i> on page 39.	Carry out test yourself or with a helper. Use a tyre gauge.
<b>Every 8 weeks</b> (depending on distance covered)	<b>Check tyre profile</b>  Minimum tread = 1 mm	Carry out visual check yourself. If the tyre profile is worn down or if the tyre is damaged, consult a specialist workshop for repairs.
<b>Every 8 weeks</b> (depending on frequency of use)	<b>Lubricate the following components with a few drops of oil</b> <ul style="list-style-type: none"> <li>– Moving parts of the locking mechanism.</li> <li>– Brake lever bearings.</li> </ul>	Do it yourself or with the aid of a helper. Components must be free from used oil residues before lubrication. Please ensure that excess oil does not contaminate the environment (e.g. your clothing).
<b>Every 8 weeks</b> (depending on frequency of use)	<b>Check all screw connections for secure fit</b>	Carry out test yourself or with a helper.
<b>Every 6 months</b> (depending on frequency of use)	<b>Check</b> <ul style="list-style-type: none"> <li>– Cleanness.</li> <li>– General condition.</li> </ul>	See Care. See Repairs.
<b>Manufacturer recommendation:</b> Every 12 months (depending on frequency of use)	Safety inspection <ul style="list-style-type: none"> <li>– Vehicle</li> </ul>	To be carried out by the specialist dealer.

## TECHNICAL DATA

All data given in the < *Technical data* > refers to the standard version.

The overall length depends on the position and size of the drive wheels.

If not noted otherwise the dimensions are determined with drive wheels of  $\varnothing$  610 mm (24").

The widths were determined with a handrim distance of 15 mm.

Dimensional tolerance  $\pm 15$  mm,  $\pm 2^\circ$ .

### Short form of wheelchair dimensions:

SH = Seat height

SW = Seat width

SD = Seat depth

BH = Back support height

### Calculation of the max. user weight:

The maximum total load is calculated on the basis of the unloaded weight of the wheelchair and the maximum passenger weight.

Additional weight due to subsequent additions or luggage reduce the maximum permissible passenger weight.

### Example:

A driver wishes to take luggage with a weight of 5 kg. Thus, the maximum user weight is reduced by 5 kg.

## Tyre pressure of pneumatic tyres

Maximum tyre pressure is printed on the tyres on each side.

### Full tyre pressure – steering wheel

Standard:

2.5 - 3.5 bar = 36 - 50 psi

### Full tyre pressure – drive wheel

Standard:

3.0 - 4.0 bar = 44 - 58 psi

Ultra-light running tyres:

6 bar = 87 psi

High pressure:

8 bar = 116 psi

## Data according to ISO for model 2.370 Smart S

	min	max
Overall length with leg support	880 mm	1030 mm
Overall width	500 mm	720 mm
Overall dimensions	10.5 kg	---
User weight (incl. additional load)	---	150 kg
Weight of the heaviest part	6.5 kg	9.5 kg
Actual seat depth	380 mm	500 mm
Actual seat width	320 mm	520 mm
Folding length	880 mm	1030 mm
Folding width	270 mm	320 mm
Folding height	700 mm	1050 mm
Seat surface height at front edge (without cushion)	390 mm	540 mm
Seat angle	0°	15°
Back support angle	90°	100°
Back support belt height	250 mm	500 mm
Foot support to seat (lower shank length)	270 mm	490 mm
Static stability downhill	---	6°
Static stability uphill	---	6°
Static stability lateral	---	6°
Dynamic stability uphill	---	6°
Angle leg support - seat surface	105°	111°
Arm support height from seat surface	210 mm	260 mm
Back support to front edge of arm support	250 mm	310 mm
Handrim diameter	490 mm	540 mm
Axle horizontal position	40 mm	100 mm
Obstacle height	0 mm	100 mm
Minimal turning radius	1200 mm	---



## Further technical data for model 2.370 Smart S

	min	max
Length without leg support	680 mm	820 mm
Overall height	700 mm	1050 mm
Seat cushion thickness	30 mm	60 mm
Length without leg supports, drive wheels (Support castors are removed or swivelled under- neath the seat)	530 mm	670 mm
Additional load:	- kg	10 kg
Transport weight (without leg supports, arm sup- ports, cushion, drive wheels)	6.5 kg	9.5 kg
<u>Steering wheel:</u>		
ø 100 mm (4"), ø 125 mm (5")	pneumatic tyres / PU / solid rubber	
ø 142 mm (5½"), ø 175 mm (7")	pneumatic tyres / PU / solid rubber	
<u>Height of push-handles</u>		
Code 502 (steplessly adjustable)	855 mm	1095 mm
<u>Drive wheel:</u>		
ø 610 mm (24 x 1 3/8"), ø 550 mm (22 x 1")	Pneumatic tyres / PU	
<u>Climatic data</u>		
Ambient temperature	-25 °C to +50 °C	
Storage temperature	-40 °C to +65 °C	

## Data according to ISO for model 2.360 Smart F

	min	max
Overall length with leg support	880 mm	1030 mm
Overall width	500 mm	720 mm
Overall dimensions	9.5 kg	---
User weight (incl. additional load)	---	150 kg
Weight of the heaviest part	7.4 kg	---
Actual seat depth	380 mm	500 mm
Actual seat width	320 mm	520 mm
Folding length	880 mm	1030 mm
Folding width	270 mm	320 mm
Folding height	700 mm	1050 mm
Seat surface height at front edge (without cushion)	430 mm	510 mm
Seat angle	2,5°	15°
Back support angle	90°	100°
Back support belt height	250 mm	500 mm
Foot support to seat (lower shank length)	0 mm	0 mm
Static stability downhill	---	6°
Static stability uphill	---	6°
Static stability lateral	---	6°
Dynamic stability uphill	---	6°
Angle leg support - seat surface	111°	111°
Arm support height from seat surface	170 mm	245 mm
Back support to front edge of arm support	250 mm	310 mm
Handrim diameter	540 mm	540 mm
Axle horizontal position	40 mm	100 mm
Obstacle height	0 mm	100 mm
Minimal turning radius	1200 mm	---

## Further technical data for model 2.360 Smart F

	min	max
Length without leg support	800 mm	950 mm
Overall height	700 mm	1050 mm
Seat cushion thickness	30 mm	60 mm
Length without leg supports, drive wheels (Support castors are removed or swivelled under- neath the seat)	730 mm	880 mm
Additional load:	---	10 kg
Transport weight (without leg supports, arm sup- ports, cushion, drive wheels)	7.4 kg	---
<u>Steering wheel:</u>		
ø 142 mm (5½")		Solid rubber
ø 100 mm (4"), ø 125 mm (5")		Solid rubber
<u>Drive wheel:</u>		
ø 610 mm (24 x 1 3/8"), ø 596 mm (24 x 1")		Pneumatic tyres / PU
<u>Height of push-handles</u>		
Code 502 (steplessly adjustable)	855 mm	1095 mm
<u>Climatic data</u>		
Ambient temperature		-25 °C to +50 °C
Storage temperature		-40 °C to +65 °C

## Meaning of the symbols on the washing instruction

(the symbols correspond to European standard)



Wash as delicates with the indicated maximum temperature in °C

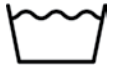

Wash as regular laundry with the indicated maximum temperature in °C



Do not bleach



Not suited for the dryer



Do not iron



Do not dry-clean

## Meaning of the labels on the wheelchair

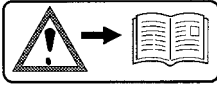

### Attention!

Read the operating manuals and other provided documentation.

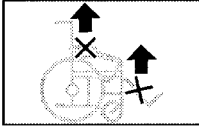

Do not lift the wheelchair at the arm supports or leg supports.

Removable parts are not suitable for carrying.

### Achtung

Bremse nachstellen.

Ident.-Nr. 8390658

### Attention

Readjust the brakes.

### Achtung

Erhöhte Kippgefahr auf Steigung / Gefälle besonders in Verbindung mit kurzem Radstand.

Ident.-Nr. 205674400

### Attention

Increased danger of tilting when on inclinations / slopes, especially in combination with short wheel base

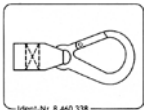

Ident.-Nr. 8 460 338

Attachment possibility of the transport securing system.



The product is **not** approved as a seat within a motor vehicle.

## Meaning of the symbols on the type plate



Manufacturer



Order number



Serial number



Production date (Year – Calendar week)



Permitted user weight



max. permissible total weight

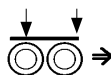

Permitted axle weights



Max. permissible rising gradient



Max. permissible falling gradient

max. ... km/h Permitted maximum speed



The product is approved as a seat within a motor vehicle



The product is **not** approved as a seat within a motor vehicle.

# INSPECTION CERTIFICATE

## Vehicle data:

Model:

Delivery note no.:

Serial-no.(SN):

### Recommended safety inspection 1st year (at least every 12 months)

Stamp of specialist dealer:

Signature: \_\_\_\_\_

Place, date: \_\_\_\_\_

Next safety inspection in 12 months

Date: \_\_\_\_\_

### Recommended safety inspection 2nd year (at least every 12 months)

Stamp of specialist dealer:

Signature: \_\_\_\_\_

Place, date: \_\_\_\_\_

Next safety inspection in 12 months

Date: \_\_\_\_\_

### Recommended safety inspection 3rd year (at least every 12 months)

Stamp of specialist dealer:

Signature: \_\_\_\_\_

Place, date: \_\_\_\_\_

Next safety inspection in 12 months

Date: \_\_\_\_\_

### Recommended safety inspection 4th year (at least every 12 months)

Stamp of specialist dealer:

Signature: \_\_\_\_\_

Place, date: \_\_\_\_\_

Next safety inspection in 12 months

Date: \_\_\_\_\_

### Recommended safety inspection 5th year (at least every 12 months)

Stamp of specialist dealer:

Signature: \_\_\_\_\_

Place, date: \_\_\_\_\_

Next safety inspection in 12 months

Date: \_\_\_\_\_

# WARRANTY / GUARANTEE

We accept legal liability for this product within the scope of or general terms and conditions and warranty and in certain cases other verbal resp. agreed upon guarantees. For warranty and guarantee demands please contact your specialist dealer with following Warranty/Guarantee section and the there included information on model description, delivery note number with delivery date and serial number (SN).

The serial number (SN) can be read off of the type plate.

Precondition for the acceptance of liability in any case is the intended use of the product, the use of original spare parts by authorised dealers as well as maintenance and inspections in regular intervals.

Guaranty is not granted for surface damages, tyres of the wheels, damages due to loosened screws or nuts as well as worn out attachment holes due to frequent assembly work.

Furthermore, damage to the drive and electronics caused by improper cleaning using steam cleaning equipment or the deliberate or accidental flooding of the components are also excluded.

Interferences through radiation sources such as mobile phones with high transmission power, HiFi-equipment and other extreme interference radiators outside of

norm specifications cannot be declared as warranty or guarantee claims.

## Attention:

- ! Failure to observe the instructions in the operating manual, improperly carried out maintenance work and, especially, technical changes and additions (add-ons) carried out without our prior consent will lead to a general loss of guarantee and product liability.

## Note:

This operating manual as a part of the product is to be handed out in case of a change of owner.

We reserve the right to make technical improvements.



The product conforms with the EC Directive 93/42/EEC (MDD) for medical products.



## Warranty / Guarantee section

Please fill out! Copy if necessary and send the copy to the specialist dealer.

# Warranty / Guarantee

Model designation:

Delivery note no.:

SN (view type plate):

Date of delivery:

Stamp of the specialist dealer:

## Inspection certificate for transfer

### Vehicle data:

Serial-no.(SN):

Model:

Delivery note no.:

Stamp of specialist dealer:

Signature: \_\_\_\_\_

Place, date: \_\_\_\_\_

Next safety inspection in 12 months

Date: \_\_\_\_\_

# **NOTES**

---



Your specialist dealer

---

---

## **MEYRA GmbH**



Meyra-Ring 2  
D-32689 Kalletal-Kalldorf



Tel +49 5733 922 - 311  
Fax +49 5733 922 - 9311



info@meyra.de

www.meyra.de

---